

Hunter Over Fences

PAS 2021



72ft



60ft



Regular Hunter Fence Heights:
 Small Ponies: 2'3"
 Medium Ponies: 2'6"
 Large Ponies/Horses: 2'9"

Entrance Gate

Low Hunter Fence Heights:
 Small Ponies: 2'
 Medium Ponies: 2'3"
 Large Ponies/Horses: 2'6"

5

Junior Western Showmanship

PAS 2021

1. Trot from A to B.
2. Stop and perform a 270° turn.
3. Walk to C.
4. Stop and set up for inspection.
5. When dismissed, perform a 90° turn.
6. Trot to line-up.

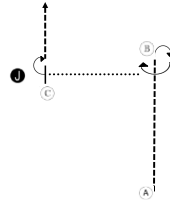

Entrance Gate

6

Senior Western Showmanship

PAS 2021

1. Trot from A halfway to B.
2. Break to walk and walk to B.
3. Stop and perform a 90° turn.
4. Back 4 steps and perform a 180° turn.
5. Trot to C.
6. Stop and set up for inspection.
7. When dismissed, perform a 90° turn.
8. Trot to line-up.

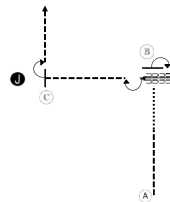

Entrance Gate

7

Junior Ranch Showmanship

PAS 2021

1. Walk from A to B
2. Stop just before B and perform a 270 degree turn
3. Trot to and around C and to judge as shown
4. Stop and set up for inspection
5. When dismissed, perform a 90 degree turn and walk away

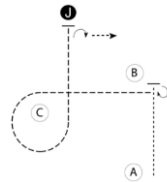

Entrance Gate

8

Senior Ranch Showmanship

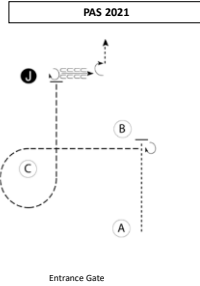

1. Walk from A to B
2. Stop just before B and perform a 270 degree turn
3. Trot to and around C as shown
4. Trot until horse's hip is even with judge
5. Stop and perform a 270 degree turn
6. Set up for inspection
7. When dismissed, back approximately one horse length
8. Perform a 90 degree turn and walk away

Junior Hunter Showmanship

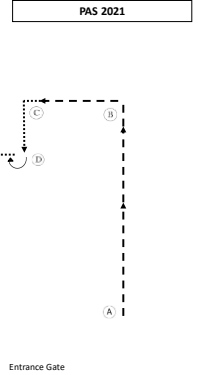

- Be ready at A.
1. Trot to and around B and to C.
 2. Break to a walk and walk around C to D.
 3. Stop & turn 90° and walk to Judge.
 4. Stop and set up for inspection.
 5. When dismissed, back approximately one horse length.
 6. Turn 90° and trot away from the Judge.

9

10

Senior Hunter Showmanship

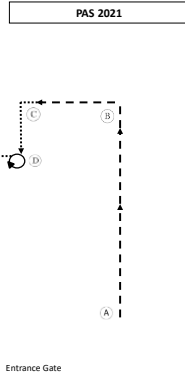

- Be ready at A.
1. Trot to and around B and to C.
 2. Break to a walk and walk around C to D.
 3. Turn 450° and walk to Judge.
 4. Stop and set up for inspection.
 5. When dismissed, back approximately one horse length.
 6. Turn 90° and trot away from the Judge.

11

Draft Showmanship

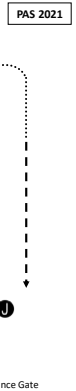

1. Enter arena at trot and line horse up on a ¼ view facing the arena fence.
2. When judge signals, back horse 5 steps off rail, turn and go to judge.
(As horse leaves line up other exhibitors will move their horses down the wall and wait for judge's signal)
3. Walk horse away from judge ¼ way down ring, trot remaining ¾.
4. Make a golf club turn & continue walk ¼ way back to judge, trot remaining ¾.
5. Stop & pose horse for inspection.
6. When excused, go to the end of the line and move up until returned to the original position.

12

Easy-Gaited & Saddle Type Showmanship

PAS 2021

Be ready at A.

1. Trot to and around B.
2. Walk from B until past Judge.
3. Back until horse's hip is even with Judge.
4. Perform a 90° turn.
5. Trot to Judge.
6. Stop and set up for inspection.
7. When dismissed, perform a 270° turn.
8. Walk straight away from Judge.

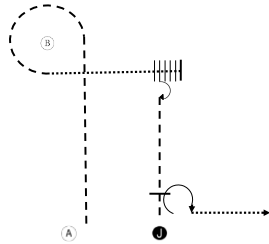

Entrance Gate

Small Equine Showmanship

PAS 2021

1. Trot from A to B.
2. Stop and perform a 270° turn.
3. Walk to C.
4. Stop and set up for inspection.
5. When dismissed, perform a 90° turn.
6. Trot to line-up.

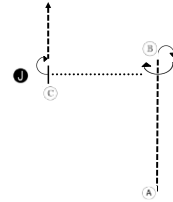

Entrance Gate

13

14

Junior Western Horsemanship

PAS 2021

Be ready before marker A.

1. Walk to A.
2. Jog to B.
3. Extended jog to C.
4. Lope left lead in circle to D.
5. Stop at D and back approximately one horse length.
6. Perform a 90° turn to the left.
7. Jog to exit.

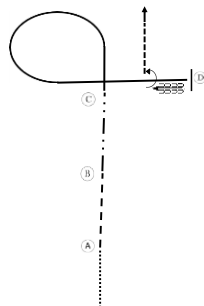

Senior Western Horsemanship

PAS 2021

Be ready before marker A.

1. Walk to A.
2. Lope on left lead to B.
3. Jog to C.
4. At C, perform a 270° turn to the right.
5. Lope on right lead to D.
6. Stop at D and back approximately one horse length.
7. Perform a 90° turn to the left.
8. Extended jog to exit.

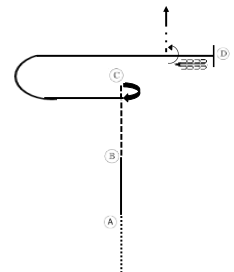

15

16

Junior Ranch Horsemanship

PAS 2021

Be ready at A.

1. Walk approximately two strides
2. Trot around B and to C
3. Extended trot circle to the right
4. Return to C and lope on the left lead to D
5. At D walk and continue for two strides
6. Stop and back to C

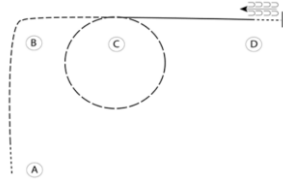

Senior Ranch Horsemanship

PAS 2021

Be ready at A.

1. Trot halfway from A to B
2. Extend the trot around B to C
3. Lope a circle around C and continue to D on the right lead
4. At D walk two strides
5. Stop and back to D

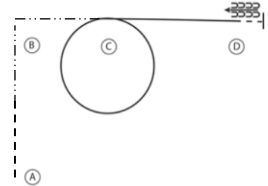

17

18

Junior Hunt Seat Equitation

PAS 2021

Be ready before A.

1. Walk to A.
2. Sitting trot from A to B.
3. Posting trot left diagonal at B. Continue circle to the right.
4. Between B and C canter left lead to D.
5. Stop at D and back one horse length.
6. Turn 90° right on forehand.
7. Posting trot right diagonal to exit.



Entrance Gate

Senior Hunt Seat Equitation

PAS 2021

Be ready before A.

1. Walk to A.
2. Sitting trot from A to B.
3. Right lead canter at B. Circle to the right.
4. Simple lead change between B and C.
5. Canter left lead to C.
6. Stop at C and back one horse length.
7. Posting trot on the right diagonal to D.
8. Stop at D.

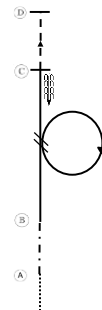

Entrance Gate

19

20

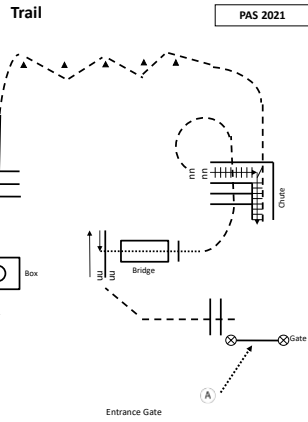

1. Begin at A. Walk to & work rope gate.
2. Jog over poles.
3. Side pass left to end of pole, then side pass right to center of pole.
4. Walk over bridge.
5. Jog over poles to chute.
6. Back through chute and jog out.
7. Jog serpentine.
8. Lope over poles to the box.
9. Walk into the box, turn 360° and walk out.

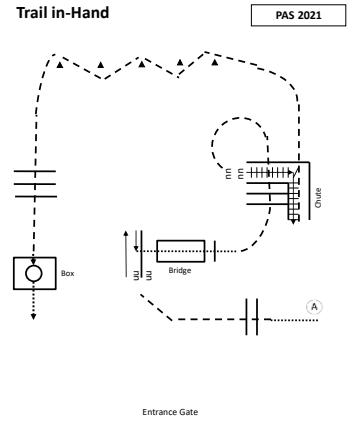

1. Begin at A at the walk.
2. Jog over poles.
3. Side pass left to end of pole, then side pass right to center of pole.
4. Walk over bridge.
5. Jog over poles to chute.
6. Back through chute, jog out.
7. Jog serpentine.
8. Jog over poles to the box.
9. Walk into the box, turn 360° and walk out.

25

26

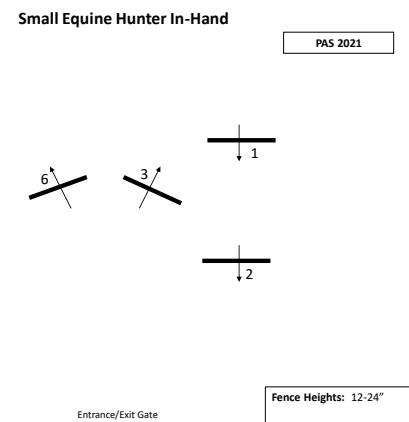
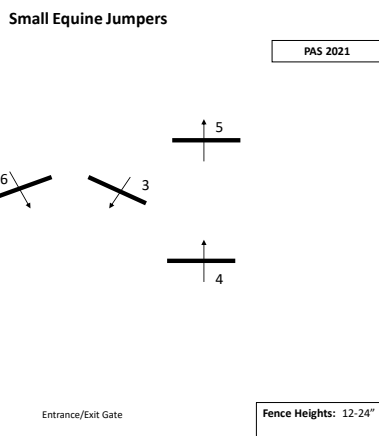

27

28

Western Riding will use pattern A from your Rulebook.

Reining will use Pattern C from your Rulebook.

Ranch Riding will use Pattern B from your Rulebook.